

PRELIMINARY
SPECIFICATIONS

MOVE THE WORLD FORWARD  MITSUBISHI
HEAVY
INDUSTRIES
GROUP

AXiA ES

PEDESTRIAN STACKERS

1.0 – 1.6 tonnes

**MAXIMISE YOUR STORAGE...
MINIMISE YOUR EFFORT**

Engineered to transform your storage capabilities,
our compact AXiA ES stackers allow you to work
productively - even in the tightest of spaces.

SPECIFICATIONS

SBP10N2	SBP16N2	SBP16N2R
SBP12N2	SBP16N2I	SBP16N2IR
SBP12N2I	SBP12N2R	SBP16N2S
SBP12PC	SBP12N2IR	SBP16N2SR
SBP14N2	SBP14N2R	
SBP14N2I	SBP14N2IR	



**WHEN
RELIABILITY IS
EVERYTHING...**

 **MITSUBISHI
FORKLIFT TRUCKS**

AXiA ES

SBP10-16N2/12PC Series

PEDESTRIAN STACKERS

1.0 – 1.6 tonnes



Engineered to transform your storage capabilities, our compact AXiA ES stackers allow you to work productively - even in the tightest of spaces.

It's all possible, thanks to this high-visibility model's compact powerhead, narrow chassis and ergonomic tiller arm.

AXiA ES is a perfect fit for your operators, too. The dual controls on the tiller arm make it suitable for left or right handed users. Its offset design maximise vision and safety.

AXiA ES lets you work more versatility, too. Whether you need to fill shelves, block stack, pick or simply transport internally, AXiA ES is your perfect partner.

For operation on ramps and uneven floors, initial lift (i) models are the best choice. A straddle leg version is available for handling bottom-boarded pallets up to a width of 1200 mm. Foldable platforms for occasional ride-on use are available on the 1.2 to 1.6 tonne stackers.

FRAME AND BODY

- **Low centre of gravity** aids stability, for safe operation.
- **High-visibility design** maximises view of fork tips and working area.
- **Ground clearance** is only 20 mm - making foot trapping unlikely.
- **Sealed chassis** offers protection against dirt, dust and other particles to reduce wear.
- **Water-resistant design** diverts splashed moisture away from key electrical components, for long truck life.
- **Chill store design*** down to 1°C, with rust-proof axles



OPERATOR ENVIRONMENT AND CONTROLS

- **Easy-to-operate tiller arm** features large, easy-use buttons so operators can focus on the task in hand.
- **Left-handed or right-handed controls** are possible, thanks to the versatile tiller arm.
- **Micro-computer*** including hour meter and battery indicator and cut out

MAST AND FORK ASSEMBLY

- **Tapered forks** enhance safety, while offering quicker and easier access to pallets in racks or block stacks.
- **Robust forks** with welded construction, and rounded tips for effortless pallet entry, give extra strength and durability.

DRIVE

- **Powerful AC drive motor** gives excellent traction and ramp performance, as well as smooth, quiet, controlled operation, extended shift length and lower maintenance requirements.
- **Oil-filled, sealed transmission*** is shock-resistant, quiet and requires little maintenance.

BRAKES

- **Parking brake** is automatically activated, when necessary, for extra safety on ramps.

STEERING SYSTEM

- **Small turning circle** together with compact chassis and excellent visibility means exceptional manoeuvrability.

ELECTRICAL AND CONTROL SYSTEMS

- **Programmable controller** adjusts acceleration, travel speed and braking to suit the application and operator - for greater versatility.
- **Battery discharge indicator** prevents deep discharge and allows for use to be monitored.
- **PIN-code access**** prevents unauthorised use of the truck.
- **Performance setting** including pre-set modes - allows instant programming without special tools.
- **Battery rollers** make changes quick, easy and safe.
- **Li-ion battery (option)*** allows for fast charging - removing the need for extra batteries.

OTHER FEATURES

- **Rapid access features** give quick and easy entry to all areas for checks and servicing.

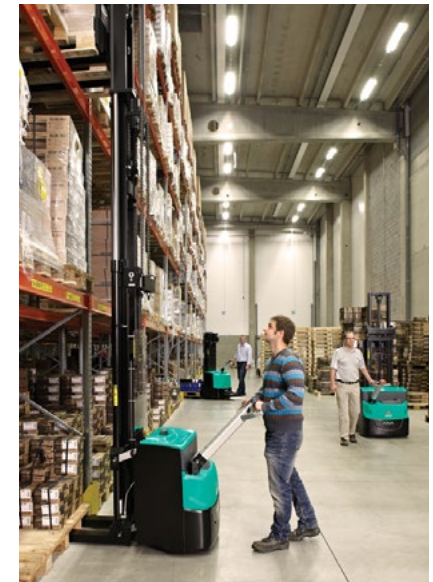

There is more information on AXiA on mitforklift.com

For more extensive information please visit our website mitforklift.com



Continuing improvement may lead to changes in these specifications.
*Only available on SBP12PC. **Standard on SBP12PC, option on the other models.



AXIA ES

OPTIONAL LI-ION BATTERY SYSTEMS FOR THE SBP12PC MODEL

MAKE YOUR FORKLIFT (AND ITS FUEL) GO EVEN FURTHER

Tried, tested and proven in the field, lead-acid batteries have been the long-standing top choice for companies employing electric lift trucks. However, with long charging times, demanding maintenance requirements, the need for extra batteries and high risk of operator misuse, it can be a challenge. Fortunately, there's a new battery system on the block: Li-ion from Mitsubishi Forklift Trucks.

Designed to meet your business' demands - including multi-shift (24/7) operations - without the need for spare batteries, our high-performance Li-ion battery system is up to 40 per cent more efficient than lead-acid counterparts. Plus, it's virtually error-proof, thanks to its ultra-low-maintenance design which prevent cell damage.



- **Exceptional, zero-emissions efficiency** 40% more efficient than lead-acid batteries and free from gases.
- **Ultra-low maintenance design** demands just a full charge each week to activate cell balancing, as well as an annual CSV export/update.
- **No space required** With no need for charging areas, there's no cost for set up and you can keep your profitable space just that: profitable..
- **Quick charge capabilities** mean that just 15 minutes is all your battery needs to keep your truck going a few more hours. (It only takes 1 to 2 hours to fully charge a completely discharged battery.)
- **Higher sustained voltage** ensures more consistent lifting and driving performance, which is particularly noticeable towards the end of a shift.
- **TriCOM Technology** delivers exceptionally high system efficiency (up to 97%).
- **Water-free design** With no water in the battery and no need to top up, there's no risk of operators damaging cells.
- **Active protection componentry** This continuously monitors the system, highlighting potential issues, including misuse.
- **Short circuit protection** is offered by system safeguards including: deep-discharge and overcharge protection, individual cell temperature and voltage monitoring.
- **On-the-go performance and monitoring** is possible thanks to the system's integrated monitoring system with easy-to-read display unit, as well as an opportunity charger on board.

SBP12PC LI-ION BATTERY AND CHARGER

Battery capacity, Ah	104
Charger capacity, Ah 1 hour	25

There is more information on Li-ion on mitforklift.com

For more extensive information please visit our website mitforklift.com



mft2.eu/ion

VDI - PERFORMANCE & DIMENSIONS

CHARACTERISTICS				Mitsubishi Forklift Trucks	Mitsubishi Forklift Trucks	Mitsubishi Forklift Trucks	Mitsubishi Forklift Trucks	Mitsubishi Forklift Trucks
1.1	Manufacturer			SBP12PC	SBP10N2	SBP12N2	SBP14N2	SBP16N2
1.2	Manufacturer's model designation			Electric	Electric	Electric	Electric	Electric
1.3	Power source			Pedestrian	Pedestrian	Pedestrian	Pedestrian	Pedestrian
1.4	Operator type			1250	1000	1200	1400	1600
1.5	Load capacity	Q	kg	600	600	600	600	600
1.6	Load center distance	c	mm	950	625	600	625	625
1.8	Load wheel axle to fork face (forks lowered)	x	mm	1473	1141	1205	1205	1205
1.9	Wheelbase	y	mm					
WEIGHT								
2.1	Truck weight without load, with maximum battery weight		kg	775	820	1205	1220	1225
2.2	Axle loadings with nominal load & maximum battery weight, drive / load side		kg	875 / 1150	740 / 1080	830 / 1575	835 / 1785	835 / 1990
2.3	Axle loadings without load & with maximum battery weight, drive / load side		kg	575 / 200	605 / 215	820 / 385	825 / 395	825 / 400
WHEELS, DRIVE TRAIN								
3.1	Tyres: PT = Power Thane, Vul = Vulkollan, P = Polyurethane, N = Nylon, R = Rubber drive / load side			Vul / Vul	Vul / Vul	Vul / Vul	Vul / Vul	Vul / Vul
3.2	Tyre dimensions, drive side		mm	230 x 70	230 x 70	230 x 70	230 x 70	230 x 70
3.3	Tyre dimensions, load side		mm	85 x 99	85 x 90	85 x 90	85 x 75	85 x 75
3.4	Castor wheel dimensions (diameter x width)		mm	140 x 60	125 x 60	125 x 60	125 x 60	125 x 60
3.5	Number of wheels, load / drive side (x = driven)			1 + 1x / 2	1 + 1x / 2	1 + 1x / 2	1 + 1x / 4	1 + 1x / 4
3.6	Track width (center of tyres), drive side	b10	mm	382	517	517	517	517
3.7	Track width (center of tyres), load side	b11	mm	355	385	385	385	385
DIMENSIONS								
4.2b	Height	h1	mm	1400 / 1550	see tables	see tables	see tables	see tables
4.3	Free lift	h2	mm	-	see tables	see tables	see tables	see tables
4.4	Lift height	h3	mm	1700 / 2000	see tables	see tables	see tables	see tables
4.5	Height with mast extended	h4	mm	2145 / 2445	see tables	see tables	see tables	see tables
4.6	Initial lift	h5	mm	-	-	-	-	-
4.9	Height of tiller arm / steering console (min./max.)	h14	mm	913 / 1368	1050 / 1372	1050 / 1372	1050 / 1372	1050 / 1372
4.15	Fork height, fully lowered	h13	mm	90	90	90	90	90
4.19	Overall length	l1	mm	1877	1836	1900	1900	1900
4.20	Length to fork face	l2	mm	677	686	750	750	750
4.21	Overall width	b1/b2	mm	660	800	800	800	800
4.22	Fork dimensions (thickness, width, length)	s/e/l	mm	65 / 185 / 1200	56 / 186 / 1150	56 / 186 / 1150	56 / 186 / 1150	56 / 186 / 1150
4.24	Fork carriage width	b3	mm		752	752	752	752
4.25	Outside width over forks (minimum / maximum)	b5	mm	540	570	570	570	570
4.26	Inner width of support legs	b4	mm	-	-	-	-	-
4.32	Ground clearance at center of wheelbase, (forks lowered)	m2	mm	25	20	20	20	20
4.33a	Working aisle width (Ast) with 1000 x 1200 mm pallets, load crosswise	Ast	mm	NA				
4.33b	Working aisle width (Ast3) with 1000 x 1200 mm pallets, load crosswise	Ast3	mm	NA				
4.33c	Working aisle width (Ast) with 1000 x 1200 mm pallets, load crosswise, platform up/down	Ast	mm		2291	2355	2355	2355
4.33d	Working aisle width (Ast3) with 1000 x 1200 mm pallets, load crosswise, platform up/down	Ast3	mm		1958	2022	2022	2022
4.34a	Working aisle width (Ast) with 800 x 1200 mm pallets, load lengthwise	Ast	mm	2507				
4.34b	Working aisle width (Ast3) with 800 x 1200 mm pallets, load lengthwise	Ast3	mm	2285				
4.34c	Working aisle width (Ast) with 800 x 1200 mm pallets, load lengthwise, platform up/down	Ast	mm		2283	2347	2347	2347
4.34d	Working aisle width (Ast3) with 800 x 1200 mm pallets, load lengthwise, platform up/down	Ast3	mm		2158	2222	2222	2222
4.35	Turning radius	Wa	mm	1835	1383	1447	1447	1447
PERFORMANCE								
5.1	Travel speed, with / without load		km/h	5.7 / 6	6.0 / 6.0	6.0 / 6.0	6.0 / 6.0	6.0 / 6.0
5.2	Lifting speed, with / without load		m/s	0.10 / 0.20	0.12 / 0.26	0.12 / 0.26	0.12 / 0.26	0.14 / 0.27
5.3	Lowering speed, with / without load		m/s	0.11 / 0.12	0.35 / 0.40	0.35 / 0.40	0.35 / 0.40	0.35 / 0.40
5.7	Gradeability, with / without load		%	7 / 19				
5.8	Maximum gradeability with / without load		%		8 / 15	8 / 15	8 / 15	8 / 15
5.9	Acceleration time (10 metres) with / without load		s	7.60 / 6.76				
5.10	Service brakes (mechanical / hydraulic / electric / pneumatic)			Electric	Electric	Electric	Electric	Electric
ELECTRIC MOTORS								
6.1	Drive motor capacity (60 min. short duty)		kW	1.3	1.0	1.0	1.0	1.0
6.2	Lift motor output at 15% duty factor		kW	2.35	2.2	2.2	2.2	3.2
6.4	Battery voltage/capacity at 5-hour discharge		V/Ah	24 / 150-230	24 / 150	24 / 150-250	24 / 150	24 / 250 - 375
6.5	Battery weight		kg	140 - 215	151	151 - 212	212	212 - 294
6.6a	Energy consumption according to EN16796		kWh/h					
MISCELLANEOUS								
8.1	Type of drive control			Stepless	Stepless	Stepless	Stepless	Stepless
10.7	Level of noise at the ear level of the driver according to EN 12 053:2001 and EN ISO 4871 in work LpAZ		dB(A)	74.6 +/- 0.7				
10.7.1	Level of noise at the ear level of the driver according to EN 12 053:2001 and EN ISO 4871, drive/lift/idle LpAZ		dB(A)		60 / 60 / 41	60 / 60 / 41	60 / 60 / 41	70 / 72 / 41
10.7.2	Whole-body vibration (EN 13 059:2002)				-	-	-	-
10.7.3	Hand-arm vibration (EN 13 059:2002)				< 2.5	< 2.5	< 2.5	< 2.5

AXIA ES

SBP10 - 16N2 / 12PC Series

PEDESTRIAN AND COMPACT STACKERS

1.0 - 1.6 tonnes



SBP10N2



SBP12PC

VDI - PERFORMANCE & DIMENSIONS

CHARACTERISTICS								
1.1	Manufacturer		Mitsubishi Forklift Trucks	Mitsubishi Forklift Trucks	Mitsubishi Forklift Trucks	Mitsubishi Forklift Trucks	Mitsubishi Forklift Trucks	Mitsubishi Forklift Trucks
1.2	Manufacturer's model designation		SBP12N2(I)	SBP14N2(I)	SBP16N2(I)	SBP12N2R	SBP14N2R	SBP16N2R
1.3	Power source		Electric	Electric	Electric	Electric	Electric	Electric
1.4	Operator type		Pedestrian	Pedestrian	Pedestrian	Pedestrian / Stand-on	Pedestrian / Stand-on	Pedestrian / Stand-on
1.5	Load capacity	Q kg	1200	1400	1600	1200	1400	1600
1.6	Load center distance	c mm	600	600	600	600	600	600
1.8	Load wheel axle to fork face (forks lowered)	x mm	625 (925)	625 (925)	625 (925)	625	925	925
1.9	Wheelbase	y mm	1205 (1615)	1205 (1615)	1205 (1615)	1205	1615	1615
WEIGHT								
2.1	Truck weight without load, with maximum battery weight	kg	1205 (1350)	1220 (1395)	1225 (1400)	1245	1435	1440
2.2	Axle loadings with nominal load & maximum battery weight, drive / load side	kg	830 (1180) / 1575 (1370)	835 (1240) / 1785 (1555)	835 (1275) / 1990 (1725)	870 / 1575	1280 / 1555	1315 / 1725
2.3	Axle loadings without load & with maximum battery weight, drive / load side	kg	820 (955) / 385 (395)	825 (970) / 395 (425)	825 (970) / 400 (430)	860 / 385	1010 / 425	1010 / 430
WHEELS, DRIVE TRAIN								
3.1	Tyres: PT = Power Thane, Vul = Vulkollan, P = Polyurethane, N = Nylon, R = Rubber drive / load side		Vul / Vul	Vul / Vul	Vul / Vul	Vul / Vul	Vul / Vul	Vul / Vul
3.2	Tyre dimensions, drive side	mm	230 x 70	230 x 70	230 x 70	230 x 70	230 x 70	230 x 70
3.3	Tyre dimensions, load side	mm	85 x 90	85 x 75	85 x 75	85 x 90	85 x 75	85 x 75
3.4	Castor wheel dimensions (diameter x width)	mm	125 x 60	125 x 60	125 x 60	125 x 60	125 x 60	125 x 60
3.5	Number of wheels, load / drive side (x = driven)		1 + 1x / 2	1 + 1x / 4	1 + 1x / 4	1 + 1x / 2	1 + 1x / 4	1 + 1x / 4
3.6	Track width (center of tyres), drive side	b10 mm	517	517	517	517	517	517
3.7	Track width (center of tyres), load side	b11 mm	385	385	385	385	385	385
DIMENSIONS								
4.2b	Height	h1 mm	see tables	see tables	see tables	see tables	see tables	see tables
4.3	Free lift	h2 mm	see tables	see tables	see tables	see tables	see tables	see tables
4.4	Lift height	h3 mm	see tables	see tables	see tables	see tables	see tables	see tables
4.5	Height with mast extended	h4 mm	see tables	see tables	see tables	see tables	see tables	see tables
4.6	Initial lift	h5 mm	- (115)	- (115)	- (115)	115	115	115
4.9	Height of tiller arm / steering console (min./max.)	h14 mm	1050 / 1372	1050 / 1372	1050 / 1372	1150 / 1350	1150 / 1350	1150 / 1350
4.15	Fork height, fully lowered	h13 mm	90	90	90	90	90	90
4.19	Overall length	l1 mm	1900 (2007)	1900 (2007)	1900 (2007)	2127 / 2607	2127 / 2607	2127 / 2607
4.20	Length to fork face	l2 mm	750 (857)	750 (857)	750 (857)	977 / 1457	977 / 1457	977 / 1457
4.21	Overall width	b1/b2 mm	800	800	800	800	800	800
4.22	Fork dimensions (thickness, width, length)	s/e/l mm	56 / 186 / 1150	56 / 186 / 1150	56 / 186 / 1150	56 / 186 / 1150	56 / 186 / 1150	56 / 186 / 1150
4.24	Fork carriage width	b3 mm	752	752	752	752	752	752
4.25	Outside width over forks (minimum / maximum)	b5 mm	570	570	570	570	570	570
4.26	Inner width of support legs	b4 mm	-	-	-	-	-	-
4.32	Ground clearance at center of wheelbase, (forks lowered)	m2 mm	20	20	20	20	20	20
4.33a	Working aisle width (Ast) with 1000 x 1200 mm pallets, load crosswise	Ast mm						
4.33b	Working aisle width (Ast3) with 1000 x 1200 mm pallets, load crosswise	Ast3 mm						
4.33c	Working aisle width (Ast) with 1000 x 1200 mm pallets, load crosswise, platform up/down	Ast mm	2355 (2653)	2355 (2653)	2355 (2653)	2773 / 3253	2773 / 3253	2773 / 3253
4.33d	Working aisle width (Ast3) with 1000 x 1200 mm pallets, load crosswise, platform up/down	Ast3 mm	2022 (2123)	2022 (2123)	2022 (2123)	2243 / 2723	2243 / 2723	2243 / 2723
4.34a	Working aisle width (Ast) with 800 x 1200 mm pallets, load lengthwise	Ast mm						
4.34b	Working aisle width (Ast3) with 800 x 1200 mm pallets, load lengthwise	Ast3 mm						
4.34c	Working aisle width (Ast) with 800 x 1200 mm pallets, load lengthwise, platform up/down	Ast mm	2347 (2533)	2347 (2533)	2347 (2533)	2653 / 3133	2653 / 3133	2653 / 3133
4.34d	Working aisle width (Ast3) with 800 x 1200 mm pallets, load lengthwise, platform up/down	Ast3 mm	2222 (2323)	2222 (2323)	2222 (2323)	2443 / 2923	2443 / 2923	2443 / 2923
4.35	Turning radius	Wa mm	1447 (1848)	1447 (1848)	1447 (1848)	1968 / 2448	1968 / 2448	1968 / 2448
PERFORMANCE								
5.1	Travel speed, with / without load	km/h	6.0 / 6.0	6.0 / 6.0	6.0 / 6.0	6.0 / 6.0	6.0 / 6.0	6.0 / 6.0
5.2	Lifting speed, with / without load	m/s	0.12 / 0.26	0.12 / 0.26	0.14 / 0.27	0.12 / 0.26	0.12 / 0.26	0.14 / 0.27
5.3	Lowering speed, with / without load	m/s	0.35 / 0.40	0.35 / 0.40	0.35 / 0.40	0.35 / 0.40	0.35 / 0.40	0.35 / 0.40
5.7	Gradeability, with / without load	%						
5.8	Maximum gradeability with / without load	%	8 / 15	8 / 15	8 / 15	8 / 15	8 / 15	8 / 15
5.9	Acceleration time (10 metres) with / without load	s						
5.10	Service brakes (mechanical / hydraulic / electric / pneumatic)		Electric	Electric	Electric	Electric	Electric	Electric
ELECTRIC MOTORS								
6.1	Drive motor capacity (60 min. short duty)	kW	1.0	1.0	1.0	1.0	1.0	1.0
6.2	Lift motor output at 15% duty factor	kW	2.2	2.2	3.2	2.2	2.2	3.2
6.4	Battery voltage/capacity at 5-hour discharge	V/Ah	24 / 150-250	24 / 250	24 / 250-375			
6.5	Battery weight	kg	151 - 212	212	212-294	24 / 150 - 250	24 / 250	24 / 250-375
6.6a	Energy consumption according to EN16796	kWh/h				151 - 212	212	212-294
MISCELLANEOUS								
8.1	Type of drive control		Stepless	Stepless	Stepless	Stepless	Stepless	Stepless
10.7	Level of noise at the ear level of the driver according to EN 12 053:2001 and EN ISO 4871 in work LpAZ	dB(A)						
10.7.1	Level of noise at the ear level of the driver according to EN 12 053:2001 and EN ISO 4871, drive/lift/idle LpAZ	dB(A)	60 / 60 / 41	60 / 60 / 41	70 / 72 / 41	60 / 60 / 41	60 / 60 / 41	70 / 72 / 41
10.7.2	Whole-body vibration (EN 13 059:2002)		-	-	-	0.8	0.8	0.8
10.7.3	Hand-arm vibration (EN 13 059:2002)		< 2.5	< 2.5	< 2.5	< 2.5	< 2.5	< 2.5

Continuing improvement may lead to changes in these specifications

VDI - PERFORMANCE & DIMENSIONS

CHARACTERISTICS			Mitsubishi Forklift Trucks	Mitsubishi Forklift Trucks	Mitsubishi Forklift Trucks	Mitsubishi Forklift Trucks	Mitsubishi Forklift Trucks
1.1	Manufacturer		SBP12N2(I)R	SBP14N2(I)R	SBP16N2(I)R	SBP16N2S	SBP16N2SR
1.2	Manufacturer's model designation		Electric	Electric	Electric	Electric	Electric
1.3	Power source		Pedestrian	Pedestrian	Pedestrian	Pedestrian	Pedestrian
1.4	Operator type		1200	1400	1600	1600	1600
1.5	Load capacity	Q kg	600	600	600	600	600
1.6	Load center distance	c mm	625 (925)	625 (925)	625 (925)	650	650
1.8	Load wheel axle to fork face (forks lowered)	x mm	1205 (1615)	1205 (1615)	1205 (1615)	1295	1295
1.9	Wheelbase	y mm					
WEIGHT							
2.1	Truck weight without load, with maximum battery weight	kg	1245 (1390)	1260 (1435)	1265 (1440)	1397	1437
2.2	Axle loadings with nominal load & maximum battery weight, drive / load side	kg	870 (1220) / 1575 (1370)	875 (1280) / 1785 (1555)	875 (1315) / 1990 (1725)	1941 / 1056	1981 / 1056
2.3	Axle loadings without load & with maximum battery weight, drive / load side	kg	860 (995) / 385 (395)	865 (1010) / 395 (425)	865 (1010) / 400 (430)	945 / 452	985 / 452
WHEELS, DRIVE TRAIN							
3.1	Tyres: PT = Power Thane, Vul = Vulkollan, P = Polyurethane, N = Nylon, R = Rubber drive / load side		Vul / Vul	Vul / Vul	Vul / Vul	Vul / Vul	Vul / Vul
3.2	Tyre dimensions, drive side	mm	230 x 70	230 x 70	230 x 70	230 x 70	230 x 70
3.3	Tyre dimensions, load side	mm	85 x 90	85 x 75	85 x 75	85 x 75	85 x 75
3.4	Castor wheel dimensions (diameter x width)	mm	125 x 60	125 x 60	125 x 60	125 x 60	125 x 60
3.5	Number of wheels, load / drive side (x = driven)		1 + 1x / 2	1 + 1x / 4	1 + 1x / 4	1 + 1x / 4	1 + 1x / 4
3.6	Track width (center of tyres), drive side	b10 mm	517	517	517	517	517
3.7	Track width (center of tyres), load side	b11 mm	385	385	385	1025-1425	1025-1425
DIMENSIONS							
4.2b	Height	h1 mm	see tables	see tables	see tables	see tables	see tables
4.3	Free lift	h2 mm	see tables	see tables	see tables	see tables	see tables
4.4	Lift height	h3 mm	see tables	see tables	see tables	see tables	see tables
4.5	Height with mast extended	h4 mm	see tables	see tables	see tables	see tables	see tables
4.6	Initial lift	h5 mm	-(115)	-(115)	-(115)	-	-
4.9	Height of tiller arm / steering console (min./max.)	h14 mm	1150 / 1350	1150 / 1350	1150 / 1350	1150/1350	1150 / 1350
4.15	Fork height, fully lowered	h13 mm	90	90	90	85	85
4.19	Overall length	l1 mm	2020 (2127) / 2500 (2607)	2020 (2127) / 2500 (2607)	2020 (2127) / 2500 (2607)	1967	2087 / 2567
4.20	Length to fork face	l2 mm	870(977)/1350(1457)	870(977)/1350(1457)	870(977)/1350(1457)	817	937 / 1417
4.21	Overall width	b1/b2 mm	800	800	800	800 / 1140-1575	800 / 1140-1575
4.22	Fork dimensions (thickness, width, length)	s/e/l mm	56 / 186 / 1150	56 / 186 / 1150	56 / 186 / 1150	40 / 100 / 1150	40 / 100 / 1150
4.24	Fork carriage width	b3 mm	752	752	752	980	980
4.25	Outside width over forks (minimum / maximum)	b5 mm	570	570	570	260-900	260-900
4.26	Inner width of support legs	b4 mm	-	-	-	1015-1450	1015-1450
4.32	Ground clearance at center of wheelbase, (forks lowered)	m2 mm	20	20	20	20	20
4.33a	Working aisle width (Ast) with 1000 x 1200 mm pallets, load crosswise	Ast mm					
4.33b	Working aisle width (Ast3) with 1000 x 1200 mm pallets, load crosswise	Ast3 mm					
4.33c	Working aisle width (Ast) with 1000 x 1200 mm pallets, load crosswise, platform up/down	Ast mm	2475 (2773) / 2955 (3253)	2475 (2773) / 2955 (3253)	2475 (2773) / 2955 (3253)	2430	2550 / 3030
4.33d	Working aisle width (Ast3) with 1000 x 1200 mm pallets, load crosswise, platform up/down	Ast3 mm	2142 (2243) / 2622 (2723)	2142 (2243) / 2622 (2723)	2142 (2243) / 2622 (2723)	2085	2205 / 2685
4.34a	Working aisle width (Ast) with 800 x 1200 mm pallets, load lengthwise	Ast mm					
4.34b	Working aisle width (Ast3) with 800 x 1200 mm pallets, load lengthwise	Ast3 mm					
4.34c	Working aisle width (Ast) with 800 x 1200 mm pallets, load lengthwise, platform up/down	Ast mm	2467 (2653) / 2947 (3133)	2467 (2653) / 2947 (3133)	2467 (2653) / 2947 (3133)	2415	2535 / 3015
4.34d	Working aisle width (Ast3) with 800 x 1200 mm pallets, load lengthwise, platform up/down	Ast3 mm	2342 (2443) / 2822 (2923)	2342 (2443) / 2822 (2923)	2342 (2443) / 2822 (2923)	2285	2405 / 2885
4.35	Turning radius	Wa mm	1567 (1968) / 2047 (2448)	1567 (1968) / 2047 (2448)	1567 (1968) / 2047 (2448)	1535	1655 / 2135
PERFORMANCE							
5.1	Travel speed, with / without load	km/h	6.0 / 6.0	6.0 / 6.0	6.0 / 6.0	6.0 / 6.0	6.0 / 6.0
5.2	Lifting speed, with / without load	m/s	0.12 / 0.26	0.12 / 0.26	0.14 / 0.27	0.14 / 0.27	0.14 / 0.27
5.3	Lowering speed, with / without load	m/s	0.35 / 0.40	0.35 / 0.40	0.35 / 0.40	0.35 / 0.40	0.35 / 0.40
5.7	Gradeability, with / without load	%	8 / 15	8 / 15	8 / 15	8 / 15	8 / 15
5.8	Maximum gradeability with / without load	%					
5.9	Acceleration time (10 metres) with / without load	s					
5.10	Service brakes (mechanical / hydraulic / electric / pneumatic)		Electric	Electric	Electric	Electric	Electric
ELECTRIC MOTORS							
6.1	Drive motor capacity (60 min. short duty)	kW	1.0	1.0	1.0	1.0	1.0
6.2	Lift motor output at 15% duty factor	kW	2.2	2.2	3.2	3.2	3.2
6.4	Battery voltage/capacity at 5-hour discharge	V/Ah	24 / 150-250	24 / 250	24 / 250-375	24 / 250-375	24 / 250-375
6.5	Battery weight	kg	151-212	212	212-294	212-294	212-294
6.6a	Energy consumption according to EN16796	kWh/h					
MISCELLANEOUS							
8.1	Type of drive control		Stepless	Stepless	Stepless	Stepless	Stepless
10.7	Level of noise at the ear level of the driver according to EN 12 053:2001 and EN ISO 4871 in work LpAZ	dB(A)					
10.7.1	Level of noise at the ear level of the driver according to EN 12 053:2001 and EN ISO 4871, drive/lift/idle LpAZ	dB(A)	60 / 60 / 41	60 / 60 / 41	70 / 72 / 41	70 / 72 / 41	70 / 72 / 41
10.7.2	Whole-body vibration (EN 13 059:2002)		0.8	0.8	0.8	-	0.8
10.7.3	Hand-arm vibration (EN 13 059:2002)		< 2.5	< 2.5	< 2.5	< 2.5	< 2.5

AXIA ES

SBP10 - 16N2 / 12PC Series

PEDESTRIAN STACKERS

1.0 - 1.6 tonnes



SBP16N2SR

MAST PERFORMANCE AND CAPACITY

AXIA ES

SBP10-16N2(I)(S)(R) / 12PC Series PEDESTRIAN STACKERS

1.0 – 1.6 tonnes

MAST TYPE	h3 + h13 mm	h1 mm	h4 mm	h2 + h13 mm	MAST TYPE	h3 + h13 mm	h1 mm	h4 mm	h2 + h13 mm
SBP10N2					SBP12/14/16N2I / SBP12/14/16N2IR				
SIMPLEX	1500	1980	1980	1500	SIMPLEX	1500	2055	2055	1505
DUPLEX	2500	1775	3000	195	2500	1940	3105	200	
	2900	1975	3400	195	2900	2140	3505	200	
	3300	2175	3800	195	3300	2340	3905	200	
SBP12PC					SBP12/14/16N2I / SBP12/14/16N2IR				
DUPLEX	1790	1400*		NA	2500	1940	3105	1360	
	2090	1550*		NA	2900	2140	3505	1560	
SBP12/14/16N2I / SBP12/14/16N2IR					SBP12/14/16N2I / SBP12/14/16N2IR				
SIMPLEX	1500	1950	1950	1500	DUPLEX FREE-LIFT	2500	1940	3105	1360
	2500	1835	3000	200		2900	2140	3505	1560
DUPLEX	2900	2035	3400	200	3300	2340	3905	1760	
	3300	2235	3800	200	3600	2490	4205	1910	
	3600	2385	4100	200	4300	2840	4905	2260	
	4300	2735	4800	200	4100	2060	4745		
DUPLEX FREE-LIFT	2500	1775	2940	1355	TRIPLEX	4300	2125	4945	
	2900	1975	3340	1555		4700	2260	5345	
	3300	2235	3800	1755		5400**	2490	6045	
	3600	2385	4100	1905		4100	2060	4745	1480
	4300	2735	4800	2255		4300	2125	4945	1545
SBP16N2S / SBP16N2SR					SBP16N2S / SBP16N2SR				
TRIPLEX	4100	1955	4640		SIMPLEX	1500	2030	2030	1500
	4300	2020	4840		2500	1915	3080	195	
TRIPLEX FREE-LIFT	4700	2153	5240		2900	2115	3480	195	
	5400**	2385	5940		3300	2315	3880	195	
	4100	1955	4640	1475	3600	2465	4180	195	
TRIPLEX FREE-LIFT	4300	2020	4840	1540	4300	2815	4880	195	
	4700	2153	5240	1673	2500	1915	3080	1355	
	5400**	2385	5940	1905	2900	2115	3480	1555	
					3300	2315	3880	1755	
					3600	2465	4180	1905	
					4300	2815	4880	2255	
					4100	2035	4720		
					4300	2100	4920		
					4700	2233	5320		
					5400	2465	6020		
					4100	2035	4720	1475	
					4300	2100	4920	1540	
					4700	2233	5320	1753	
					5400	2465	6020	1905	

* h1 closed mast height includes poly carbonate finger protection. Mast height excl. Finger protection is 1343mm / 1493mm.
** Only SBP14N2-16N2 & SBP14N2I-16N2I

- S = Simplex
- DS = Duplex with clear-view mast
- DEV = Duplex with full free lift
- TR = Triplex with clear-view mast
- TREV = Triplex with full free lift
- h3+h13 = Lifting height
- h1 = Lowered mast height
- h4 = Raised mast height
- h2+h13 = Free lift

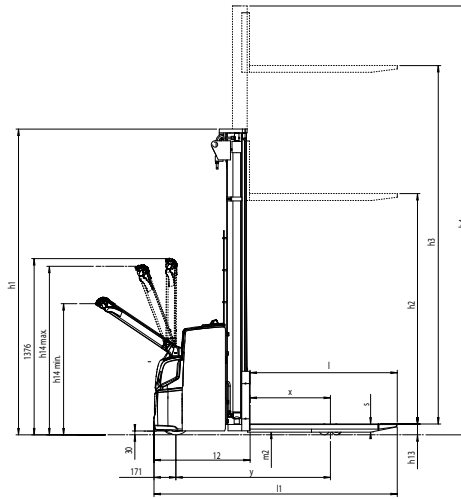

$Ast = \text{Working aisle width}$
 $Ast3 = \text{Working aisle width (} b12 < 1000 \text{ mm)}$
 $Ast = Wa + \sqrt{(l6 - x)^2 + (b12/2)^2} + a$
 $Ast3 = Wa + l6 - x + a$

$Wa = \text{Turning radius}$
 $l6 = \text{Pallet length}$
 $x = \text{Load wheel axle to fork face}$
 $b12 = \text{Pallet width}$
 $a = \text{Safety clearance} = 2 \times 100 \text{ mm}$

SBP10 / 12 / 14 / 16N2

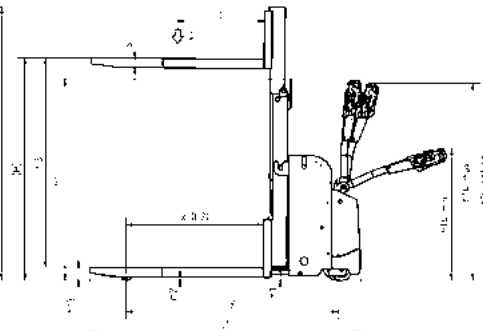
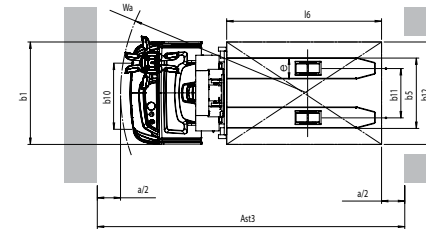

SBP12PC

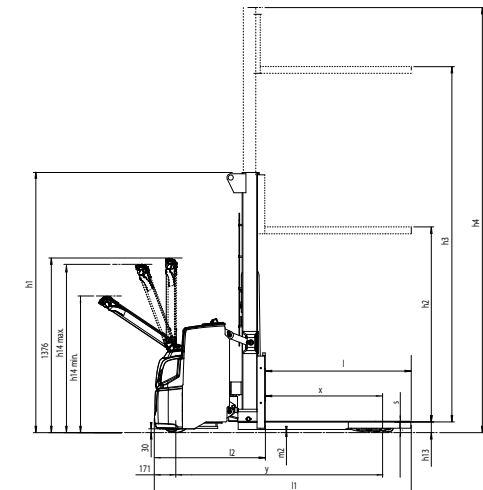
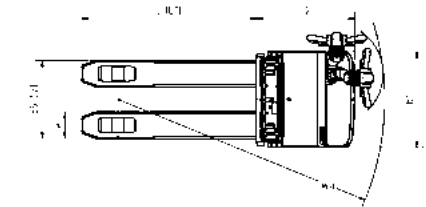

SBP12 / 14 / 16N2I

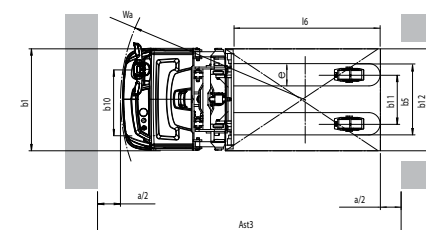

MAST PERFORMANCE AND CAPACITY

AXIA ES

SBP10-16N2/12PC Series

PEDESTRIAN STACKERS

1.0 – 1.6 tonnes

Ast = Working aisle width
 Ast3 = Working aisle width (b12 < 1000 mm)
 $Ast = Wa + \sqrt{(l6 - x)^2 + (b12/2)^2} + a$
 Ast3 = $Wa + l6 - x + a$

Wa = Turning radius
 l6 = Pallet length
 x = Load wheel axle to fork face
 b12 = Pallet width
 a = Safety clearance = 2 x 100 mm

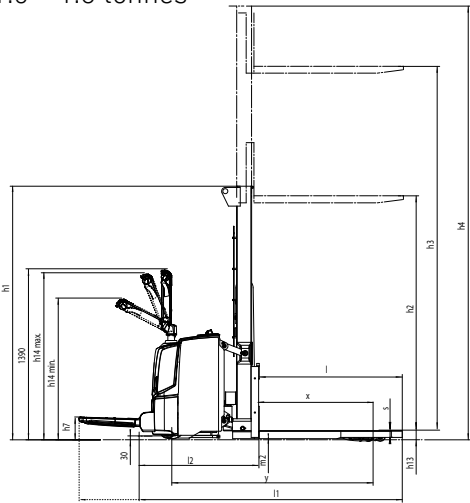

**SBP12 / 14 / 16N2(I)R
WITH FOLDING PLATFORM**

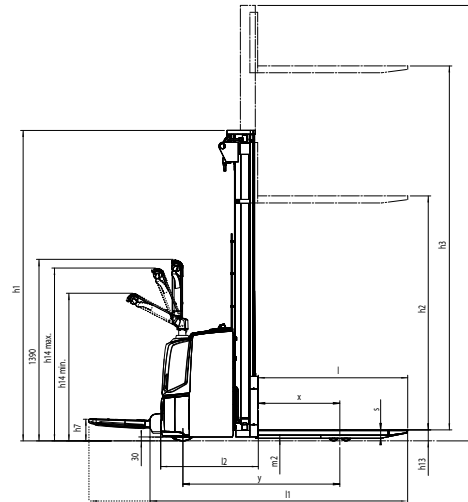
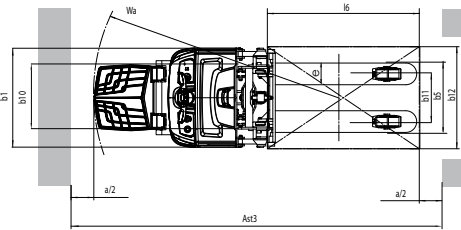

**SBP12 / 14 / 16N2R
WITH FOLDING PLATFORM**

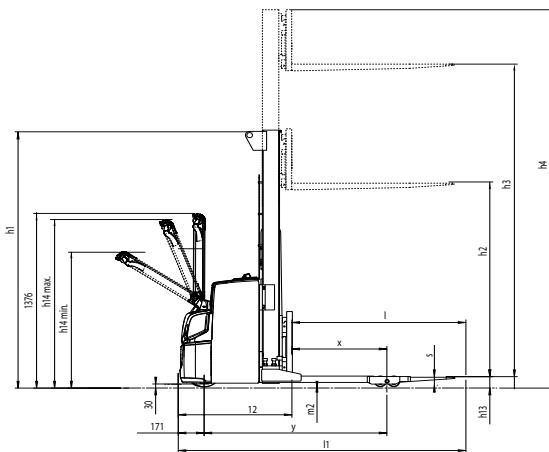
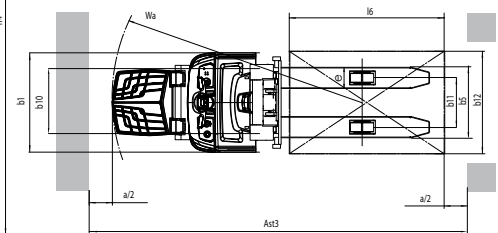

SBP16N2S

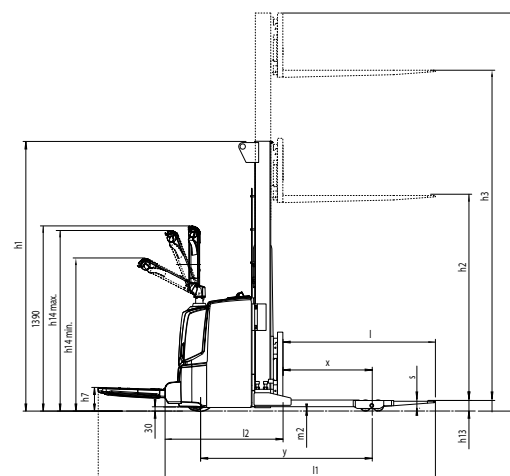
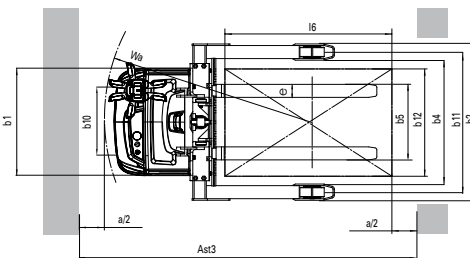

**SBP16N2SR
WITH FOLDING PLATFORM**

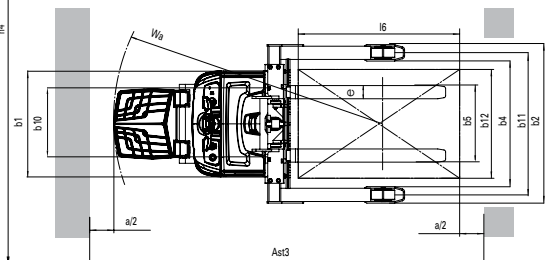

STANDARD EQUIPMENT & OPTIONS

- = Standard
- = Standard on initial lift models only
- = Option

	SBP10N2	SBP12PC	SBP12N2(I)	SBP14N2(I)	SBP16N2(I)	SBP12N2(I)R	SBP14N2(I)R	SBP16N2(I)R	SBP16N2S	SBP16N2SR
GENERAL										
LED discharge indicator, no hour meter	●		●	●	●	●	●	●	●	●
Multifunctional display, including hour meter	●		●	●	●	●	●	●	●	●
Micro-computer incl. hour meter and battery indicator with cutout (ATC T4)		●								
PIN code login 100 codes		●								
PIN code login 4 codes	●		●	●	●	●	●	●	●	●
Offset tiller arm with display and keypad		●								
Chill store design, down to 1°C, with rust-protected axles		●								
Proportional valve for lifting and lowering, controlled by fingertip lever on tiller head	●		●	●	●	●	●	●	●	●
Electric on/off valve for lifting and lowering, controlled by rocker switch on tiller head		●								
Polyurethane drive wheel	●	●	●	●	●	●	●	●	●	●
Polyurethane drive wheel or rubber		●								
Initial lift			●	●	●	●	●	●		
Single load wheels polyurethane	●	●	●	●	●	●	●	●		
Tandem load wheels polyurethane	●	●	●	●	●	●	●	●	●	●
Adjustable width between straddle load legs; 900mm - 1300mm									●	●
Sideways battery change (250Ah battery only)			●	●	●	●	●	●	●	●
Li-ion batteries		●							●	●
ENVIRONMENT										
Cold store design, 0C° to -35C°	●	●	●	●	●	●	●	●	●	●
DRIVE AND LIFT CONTROLS										
Heavy duty tiller head - with key switch entry		●								
Tiller in line with chassis contour		●								
Tiller up drive	●	●	●	●	●	●	●	●	●	●
WHEEL OPTIONS										
Polyurethane traction and load wheels	●	●	●	●	●	●	●	●	●	●
Power friction traction wheel	●	●	●	●	●	●	●	●	●	●
Non-marking drive wheel		●								
Anti-static drive wheel		●								
OTHER OPTIONS										
Speed reduction 0,5km/h above 1000mm lift, duplex and triplex masts without free lift			●	●	●	●	●	●	●	●
Speed reduction 0,5km/h above free lift, duplex and triplex masts with free lift			●	●	●	●	●	●	●	●
Inbuilt charger, 30A	●		●	●	●	●	●	●	●	●
Rubber foot protection			●	●	●	●	●	●	●	●
Diselectric band		●								
Key switch	●	●	●	●	●	●	●	●	●	●
Piezo buzzer instead of standard horn		●								
Special RAL colour	●	●	●	●	●	●	●	●	●	●
Load backrest	●	●	●	●	●	●	●	●	●	●
Accessory rack	●	●	●	●	●	●	●	●	●	●
List bracket, A4 size	●	●	●	●	●	●	●	●	●	●

*Only available on SBP12PC. ***Not available on SBP12PC.

AXIA ES SBP10-16N2/12PC Series

PEDESTRIAN STACKERS

1.0 – 1.6 tonnes



Rubber foot protection

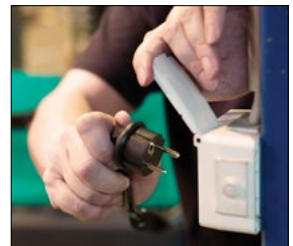

Sealed inbuilt charger



Equipment bar for mounting accessories (on most models)

WHEN RELIABILITY IS EVERYTHING...



AXIA
THE ALL ROUNDER

With a name that reflects its manoeuvrability, AXIA combines award-winning ergonomics with high performance and low maintenance features to deliver a complete warehouse support package.

Efficient, versatile and durable, AXIA is the perfect choice for every workplace.

Like any product bearing the "MITSUBISHI" name our materials handling equipment benefits from the tremendous heritage, huge resources and cutting-edge technology of one of the world's largest corporations – Mitsubishi Heavy Industries Group.

Engineering spacecraft, jet planes, power plants and more, MHI specialises in those technologies where performance, dependability and superiority decide your success or failure...

So when we promise you quality, reliability and value for money, you know it's a guarantee we have the power to deliver.

That's why every model in our award-winning and comprehensive range of lift trucks and warehouse equipment is built to a high specification – to ensure it keeps working for you. Day after day. Year after year. Whatever the job. Whatever the conditions.

YOU'LL NEVER WORK ALONE

As your local authorised dealer, we are here to keep your trucks working – through our extensive experience, our technical excellence and our commitment to customer care.

We are your local experts, backed by efficient channels to the entire organisation of Mitsubishi Forklift Trucks.

No matter where you are, we are close by – with the capability to meet your needs.

Discover how Mitsubishi Forklift Trucks give you more from your local authorised dealer or when you visit our website www.mitforklift.com

Performance specifications may vary depending on standard manufacturing tolerances, vehicle condition, types of tyres, floor or surface conditions, applications or operating environment. Trucks may be shown with non-standard options. Specific performance requirements and locally available configurations should be discussed with your distributor of Mitsubishi forklift trucks. We follow a policy of continual product improvement. For this reason, some materials, options and specifications could change without notice.

mitforklift@mcfe.nl

WESM1989 (10/19) © 2019 MCFE



Mitsubishi Caterpillar Forklift Europe B.V.
Hefbrugweg 77, 1332 AM Almere
The Netherlands
Tel: +31 (0)36 5494 411



mft2.eu/fb



mft2.eu/apps



mft2.eu/youtube



mft2.eu/facebook

